

**Bart's Electrical Service**  
**Fuel gard**  
**(213) 595-5075**

Tank For Stationary Use Only

Capacity	4,000 Gallons	Heads Primary	1/4"	Paint Ext.	Red Primer
Design	Singlewall	Shell Primary	1/4"	Paint Int.	
Code	UL 142	Heads Secondary		Weight Empty	5,000 lbs.
Test Pres.	5 PSI	Shell Secondary		Rev.#	Date:

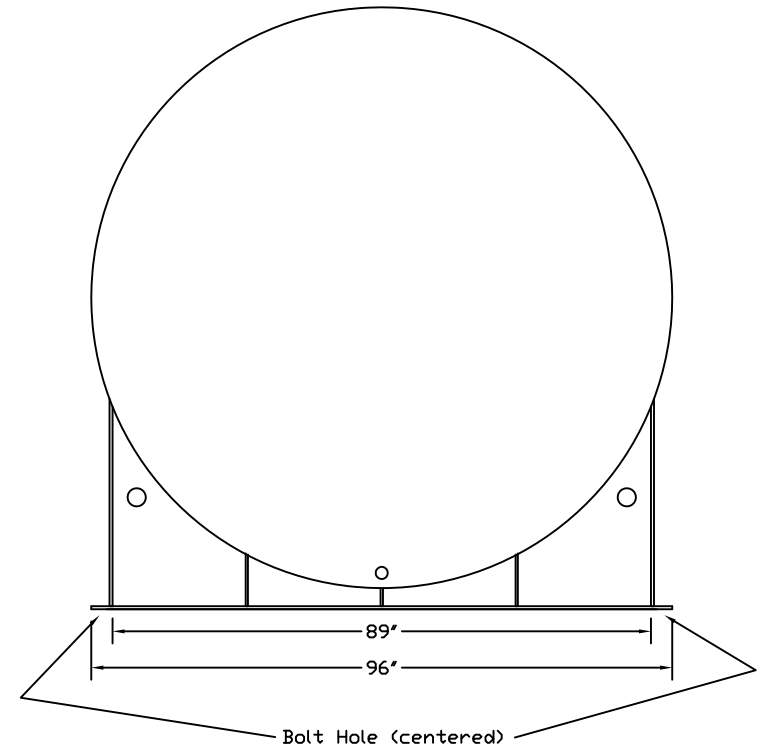
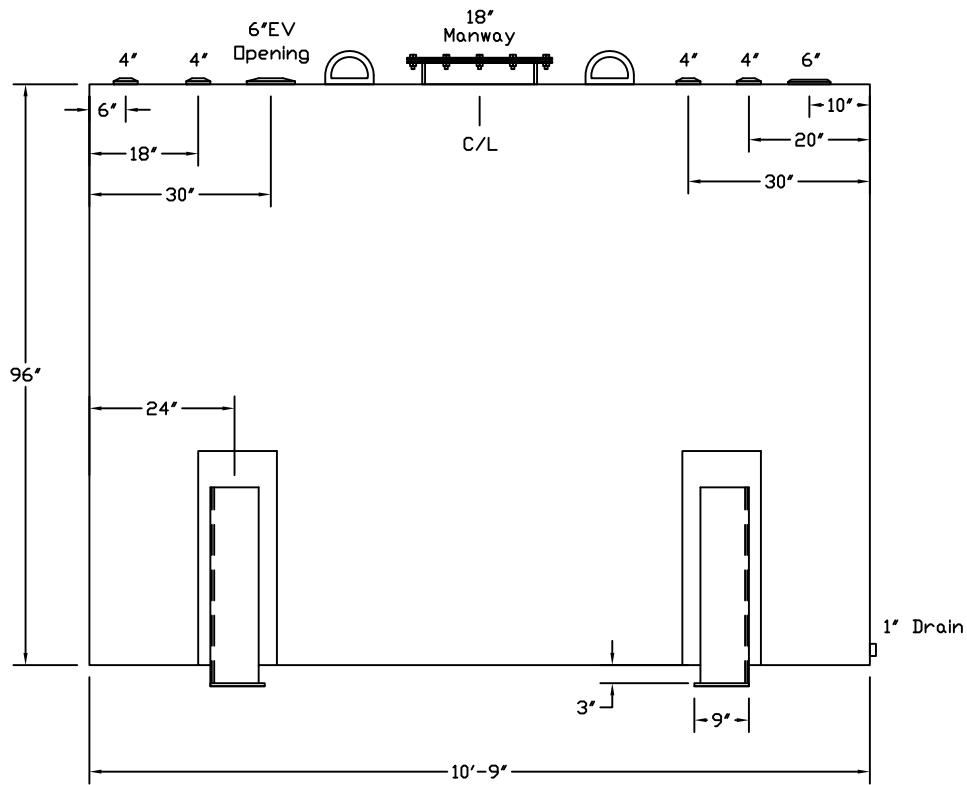

Customer: \_\_\_\_\_ Drg. Date: \_\_\_\_\_

Quoted Lead Times Begin Upon Receipt of signed Approved Drawing, Which Must be Returned Before Production Can Begin.

Drawing Approved By: \_\_\_\_\_